

Manual Piatto

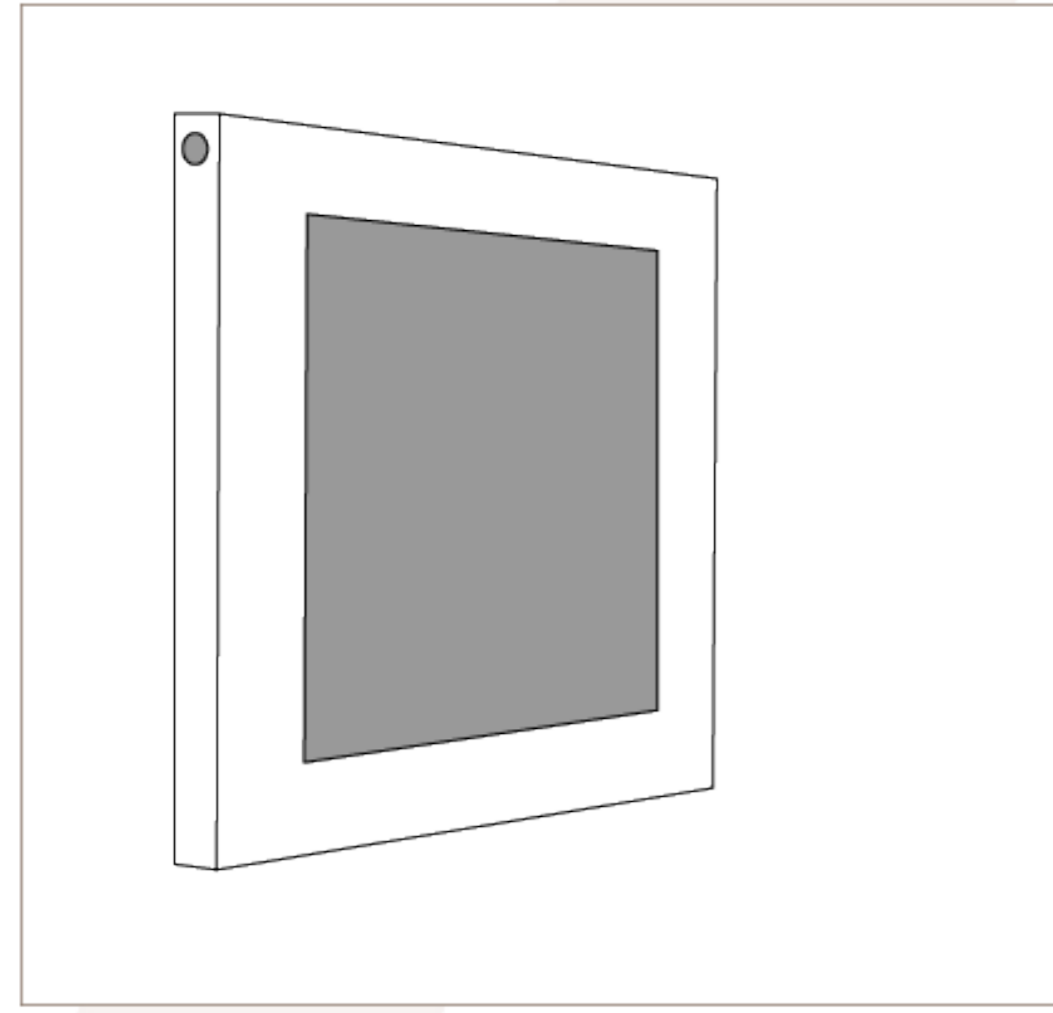

1

Optionally add rubbers for tighter fit of the tablet.

2

Mount tablet to the wall using M6 screws.

Slide the tablet in as shown.

3

Insert the lock unit into the side of the casing

4

In the top you find the hole for the safety screw. Fit the screw with the supplied tool

5

You can guide your cables along the wall through the hole in the middle via one of the grooves.

Content

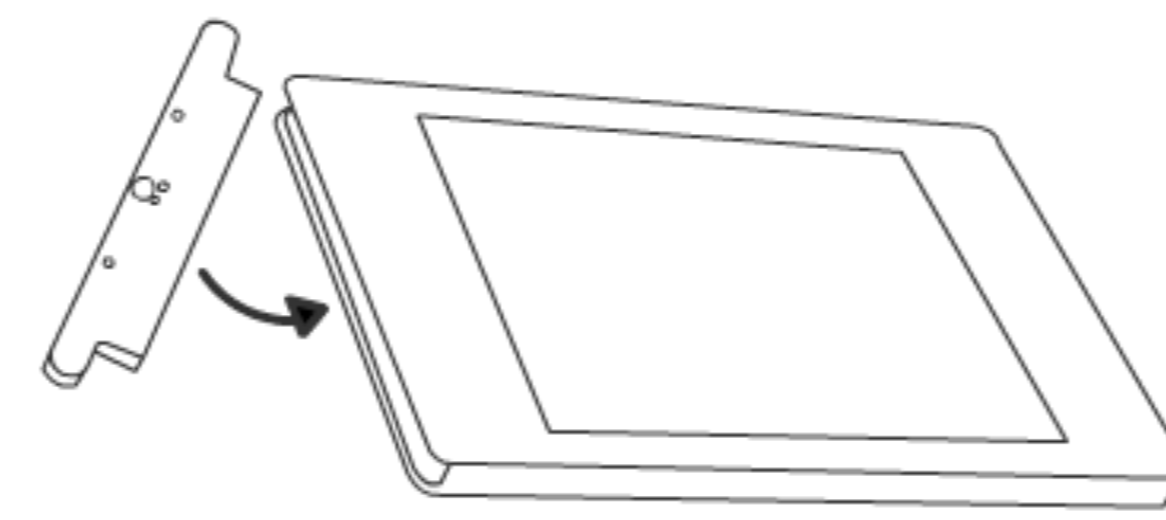

1 Piatto casing

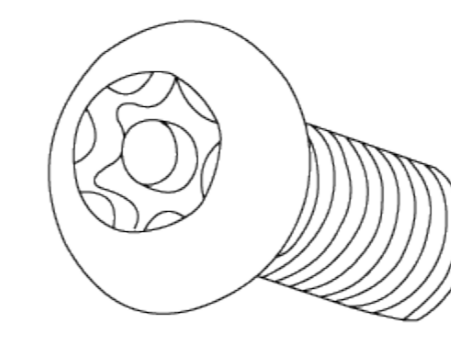

1 safety screw

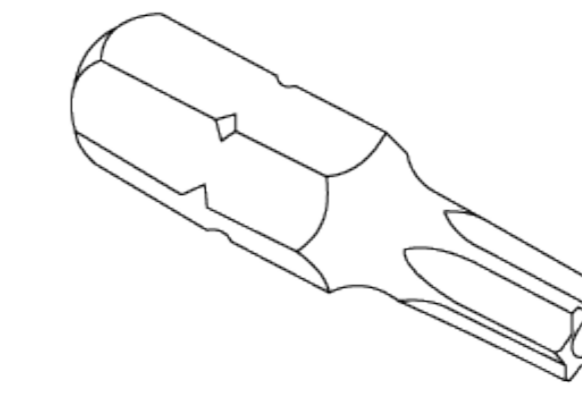

1 safety screw tool



2 rubbers

Necessities

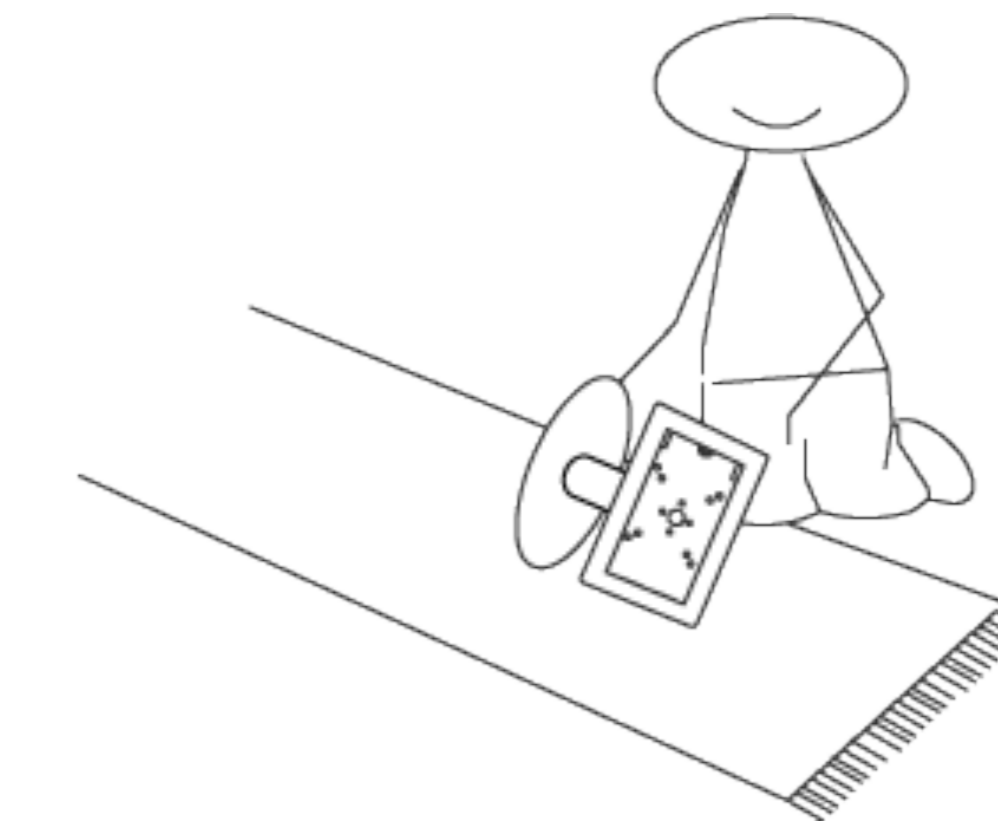
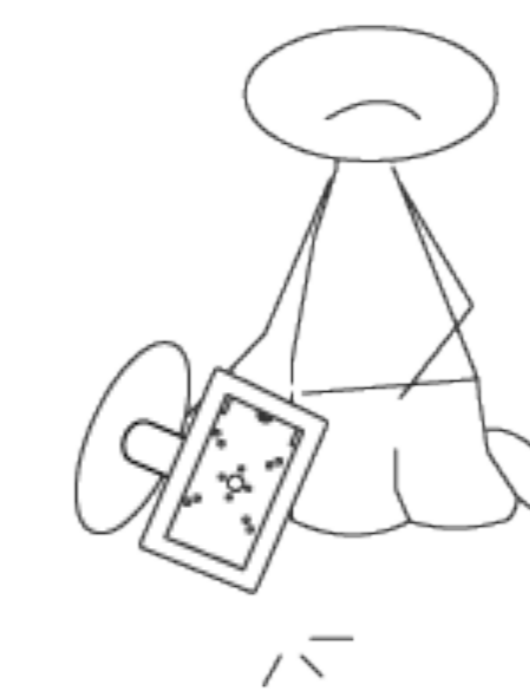
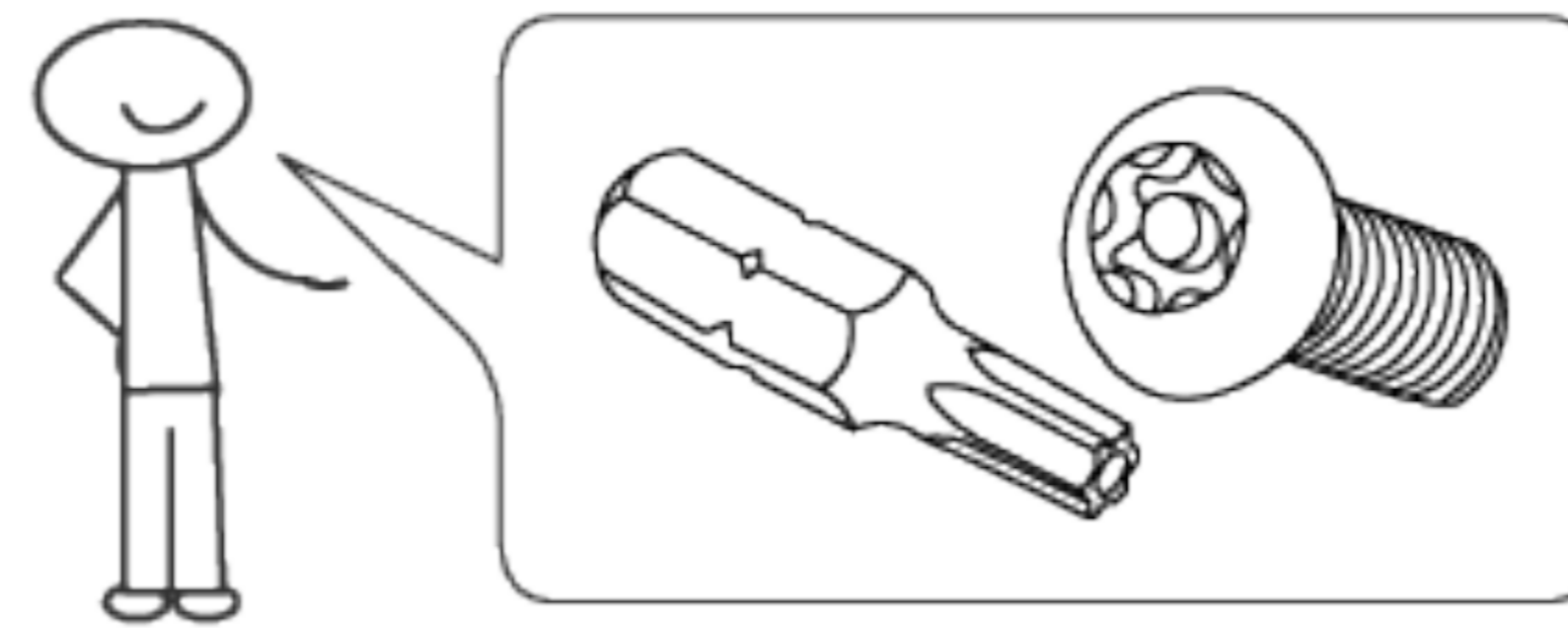

NOTE: Use a soft underlayment during assembly to avoid damage

Explanation

1

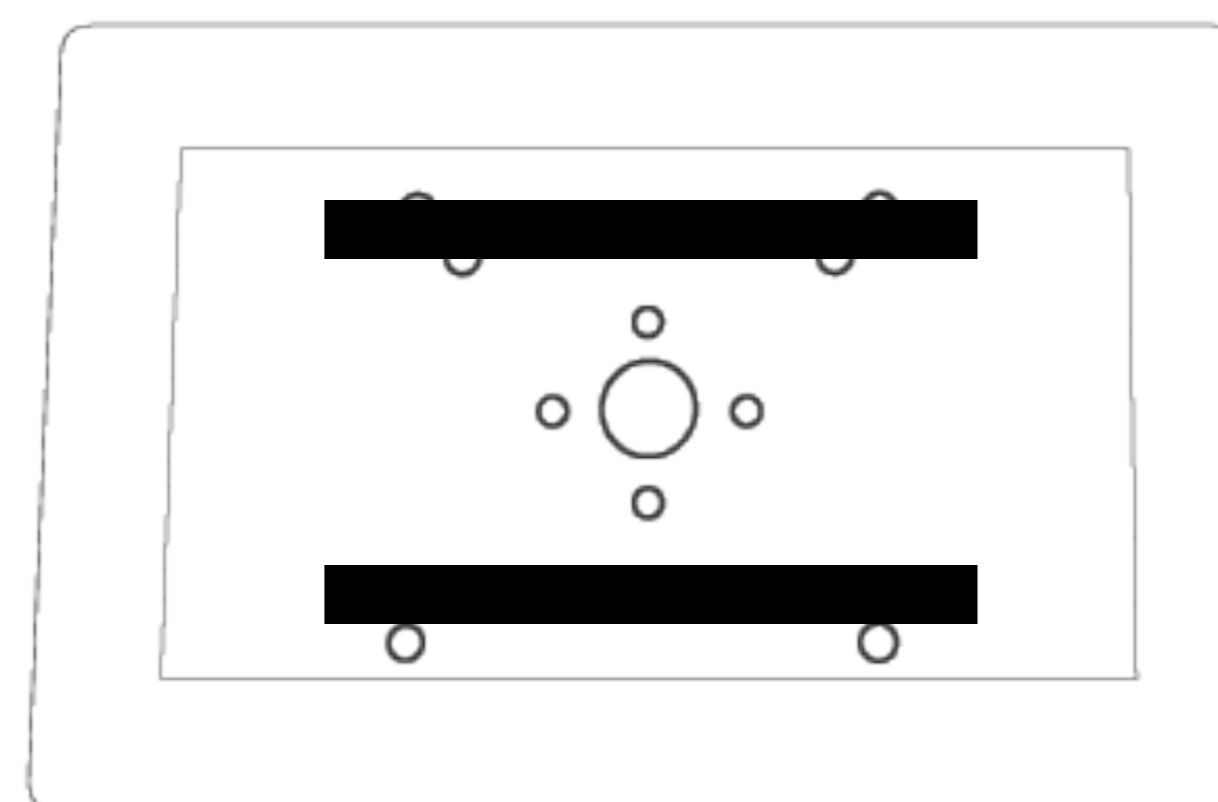

3

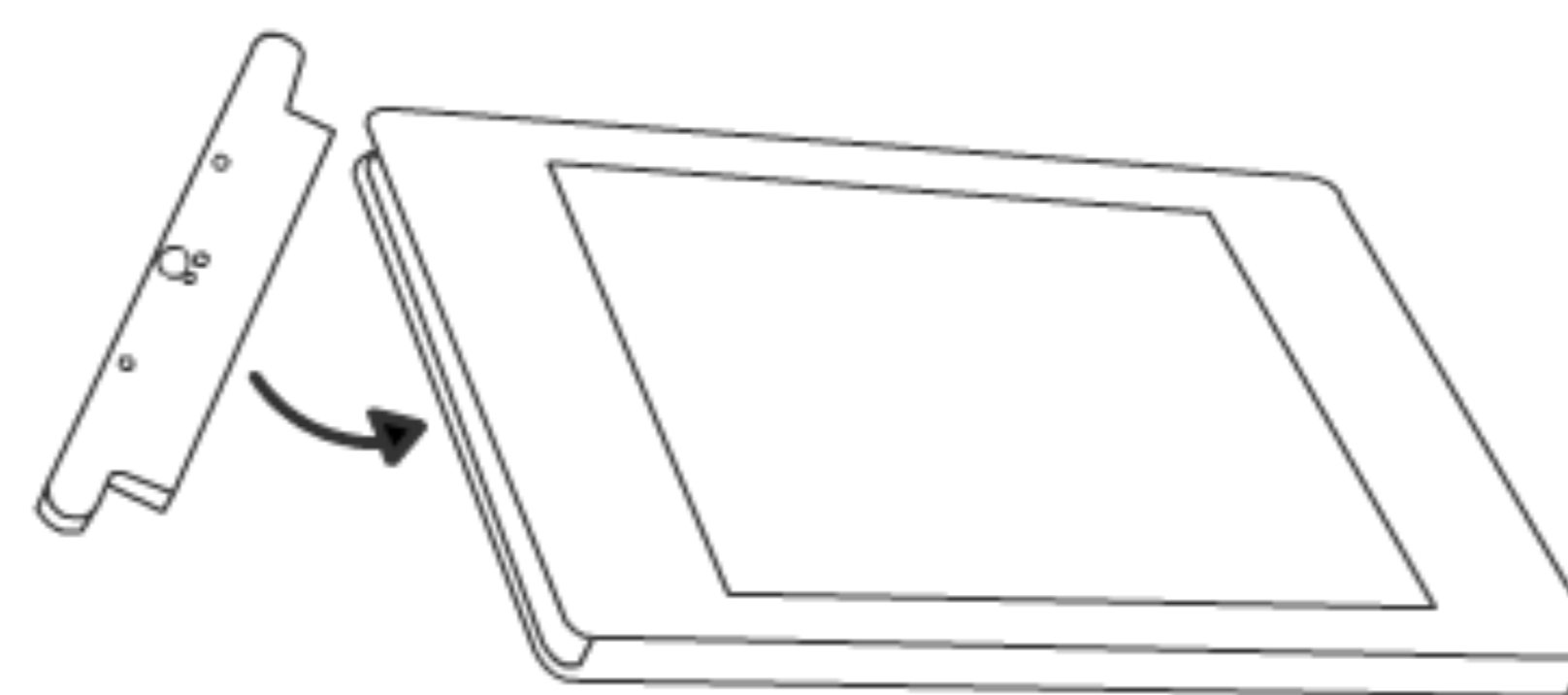

5

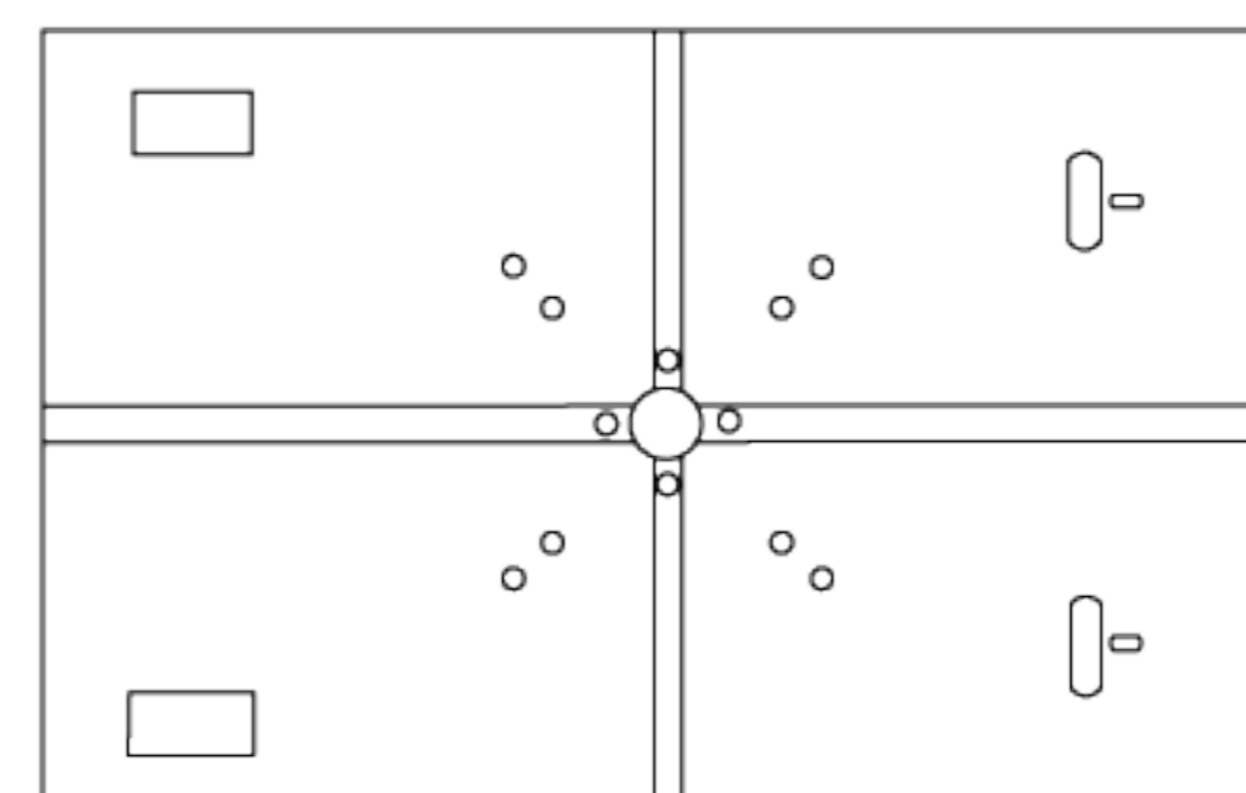

2

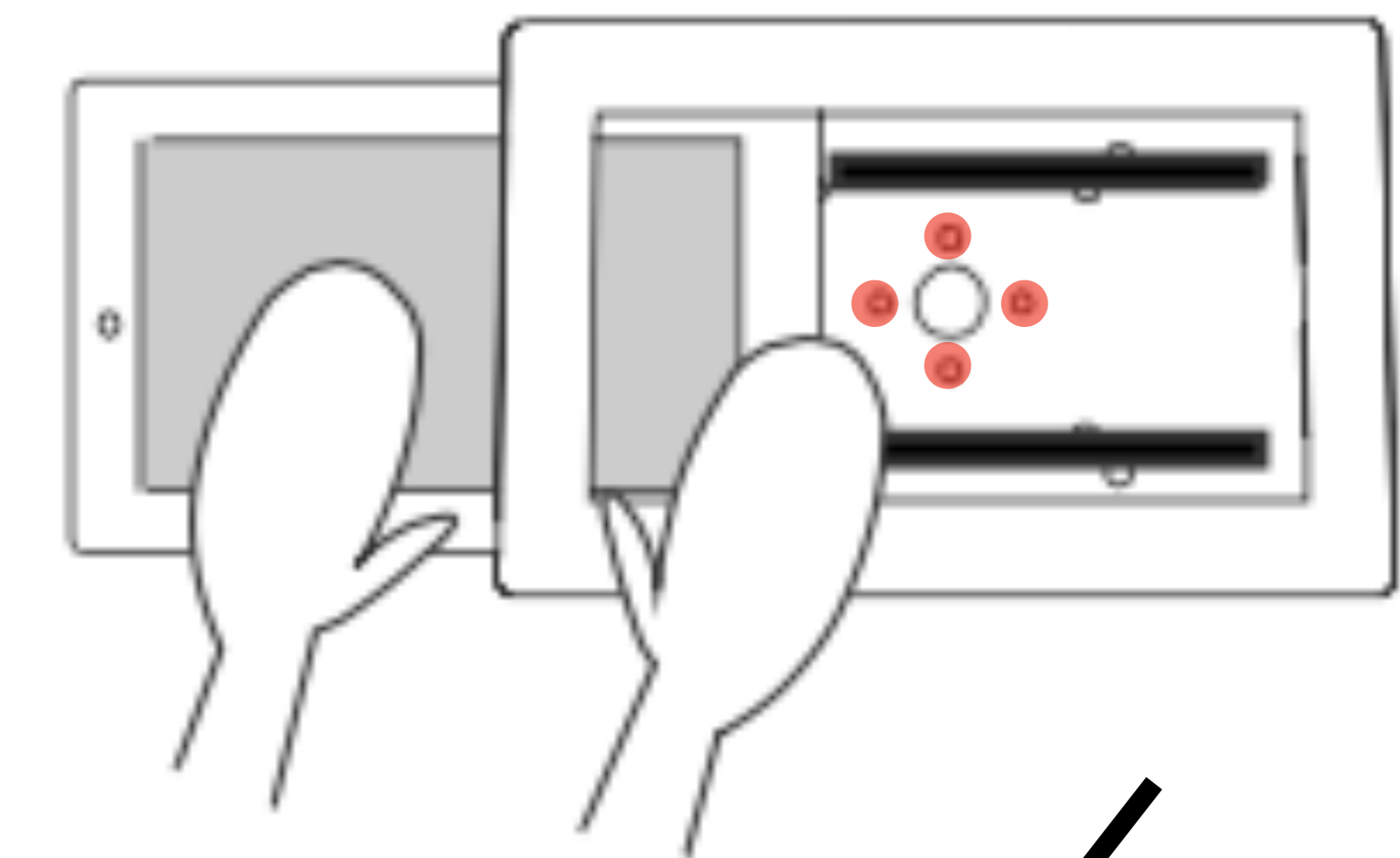

4

